

Heavy duty vises

Industrial bench vises



Similar to clamps, vises are like another pair of hands in the shop. They hold your work securely so that you can saw, grind or drill with both hands. BESSEY® vises have been chosen and offered with an eye for durability and functionality. BESSEY heavy-duty bench vises are made from high quality ductile grey cast iron for many years of service. Many models have swivel bases. All are backed up by BESSEY's limited lifetime warranty. Quality you can trust.

1 Choices

A range of products from light duty to heavy duty.

2 Made for everyday work

Heavier duty offerings include an anvil, hardened steel jaws and a 360 degree swivel base (270 degrees on the BV-MPV5)

3 Robust construction

Strong ductile cast iron construction. Light weight, stronger performance than gray cast (BV-MPV5, BV-HD40, BV-HD60).

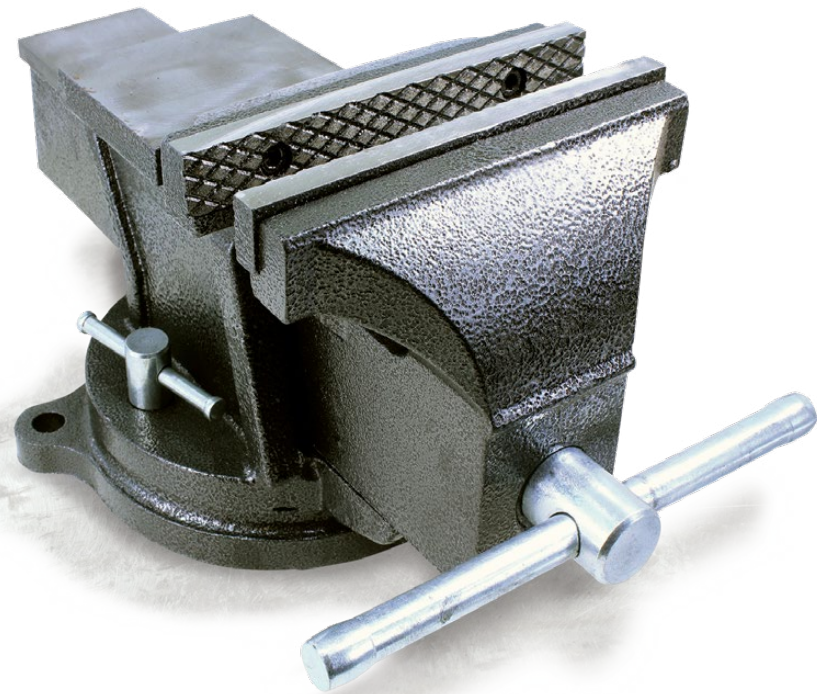

Multi-purpose vise (rotating pipe and bench vise)

Simply bolt this vise to the top surface of your bench and lock your workpiece in place with the heavy duty jaws. The base swivels 360° with 3 mounting holes and 2 lockdowns. Pipes are no problem with the serrated jaws that rotate 360°. Made with a ductile iron body for durability. Built-in anvil.

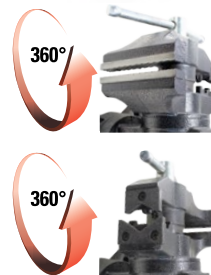

	Jaw Width	Jaw Opening	Throat Depth	Pipe Capacity	Approx. Weight
BV-MPV5	5"	5"	2 3/4"	2"	29 lbs

Heavy duty bench vise

Simply bolt this vise to the top surface of your bench and lock your workpiece in place with the heavy duty serrated jaws. The base swivels 360° with 3 mounting holes and 2 lockdowns. Made with a ductile iron body for durability. Built-in anvil.

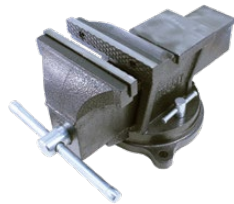

	Jaw Width	Jaw Opening	Throat Depth	Approx. Weight
BV-HD40	4"	4"	2"	13 lbs
BV-HD60	6"	6"	2 3/4"	27 lbs

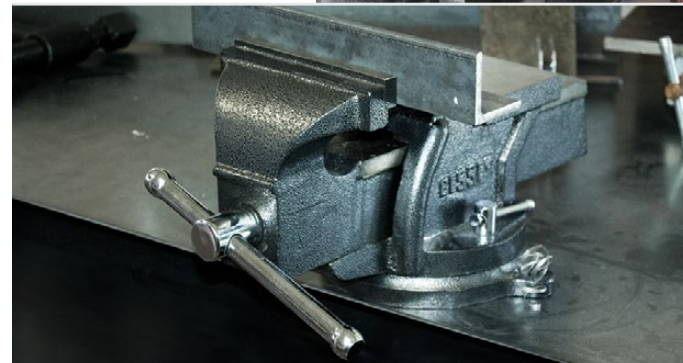

Light duty bench vise

The base swivels 270° with 4 mounting holes and 1 lockdowns. Made with a cast iron body for durability. Built-in anvil.

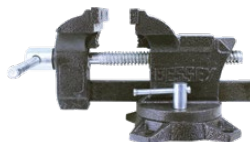

	Jaw Width	Jaw Opening	Throat Depth	Pipe Capacity	Approx. Weight
BV-HW45	4 1/2"	4"	1 3/4"	1"	11 lbs



Vises



Drill press vise

Malleable cast iron body with a powder coated finish. Machined spindle. A grooved jaw provides a firm secure grip. The holes are elongated for easy fastening onto a drill press or work surface.



	Jaw Width	Jaw Opening	Throat Depth	Approx. Weight
BV-DP40	4"	4 1/2"	1 1/8"	11 lbs

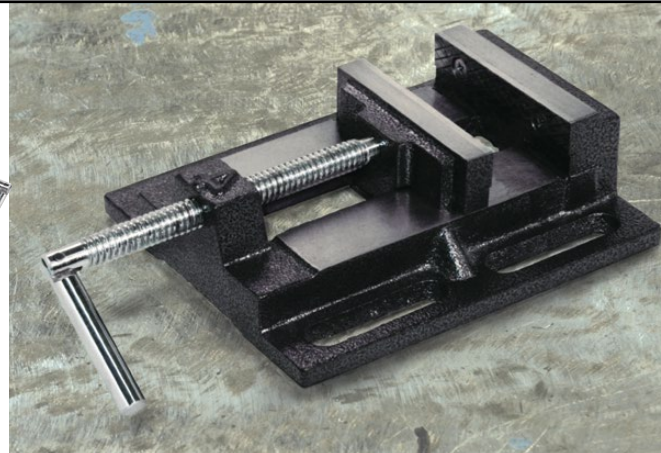

Light duty clamp-on vise

When bench space is at a premium this vise is the perfect answer. Completely portable and ideal for light duty work. This clamp attaches to surfaces up to 1.5" thick. Cast in pipe jaws, serrated jaw faces, and double steel guide bars.



	Jaw Width	Jaw Opening	Throat Depth	Pipe Capacity	Approx. Weight
BV-CO30	3"	3"	1 1/2"	3/4"	5 lbs

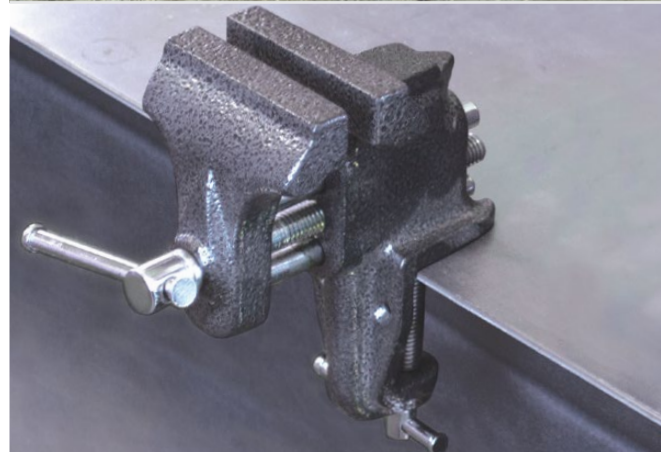

Vacuum base vise (swivelling)

This portable hobbyist vise attaches securely to any non-porous surface and, by releasing the locking ring can rotate and swivel and, be re-locked. Comes with non-slip rubber pads for vise jaws.



	Jaw Width	Jaw Opening	Approx. Weight
BV-VB	2 3/4"	2 3/4"	4.50 lbs



Multi-purpose vise jaws

Designed to fit any 3-6" vise jaw. The magnetic back helps to keep it in place. Works great for holding wood, metal and tubing. Non-marring



	Jaw Width	Approx. Weight
BV-NVJ	5 1/2"	0.50 lbs

Light duty wood vise

This is a versatile vise for home or work. Jaws are pre-drilled for attaching wood facing. For light duty work, made with a cast iron body.



	Jaw Width	Jaw Opening	Throat Depth	Approx. Weight
BV-WV65	6"	6"	2 5/8"	8.50 lbs

Heavy duty industrial bench vise

BESSEY® industrial bench vise series sets new standards for durable work holding. 100% guaranteed unbreakable drop forged moveable jaws, stationary base and swivel base (*) for the toughest jobs.



	Jaw Width	Jaw Opening	Throat Depth	Approx. Weight
BV-DF4SB	4"	4 1/4"	2 3/8"	14.00 lbs
BV-DF5SB	5"	6 1/2"	3"	25.20 lbs
BV-DF6SB	6"	7"	4"	50.00 lbs
BV-DF8SB	8"	10 1/2"	4 1/4"	67.30 lbs

BESSEY vises with drop forged components are guaranteed against breakage in normal use. This guarantee does not cover abuse, improper use, or handling and storage of the product. Never use cheater bars or pipes to extend the spindle handle. This will void the warranty and can cause injury.

